

# ***S-FOLD WAVE FOLD***





TBS (Aust) Pty Ltd is an Australian owned and operated company which imports, wholesales and provides a made to measure service to the window covering industry. TBS has a focus on working alongside some of Australia's largest architects, developers, commercial and high street retailers with a view to being able to offer a full suite of products for any type of development.

TBS continues to look for a competitive advantage realising that many architects and end users want to make a statement with their window furnishings. TBS offers the ability to provide custom made solutions for Motorised Curtains and Blinds, Roller Blinds, Aluminium and Timber Venetian Blinds, Pole Sets, Panel Tracks, Vertical Blinds and an extensive range of curtain tracking systems including applications for residential homes, hospitals, aged care, psychiatric wards, theatres and hotel developments.

With this philosophy TBS has expanded to have distributorship or representation in South Australia, Western Australia, New South Wales and Queensland with the market being serviced from our customer service centre in Melbourne and warehouses in Melbourne, Sydney and Brisbane.

## Contents

Wave Fold Product Specifications		4
Designer 10 Wave Fold		5
Designer 15 Wave Fold		6
System 20 Wave Fold		7
Designer 25 Wave Fold		8
Designer 38 Wave Fold		10
Saber Motor Wave Fold		12
Heavy Duty Wave Fold		13
S-Fold Product Specification		16
Designer 10 S-Fold		17
Designer 15 S-Fold		18
System 20 S-Fold		19
Designer 25 S-Fold		20
Designer 38 S-Fold		22
Saber Motor S-Fold		24
Heavy Duty S-Fold		25
Pelmet / Bulkhead Allowances		26
Bracket Covers		27

# WAVE FOLD

## STRING RUNNERS

A13-101505 | non-wheeled wave fold carrier

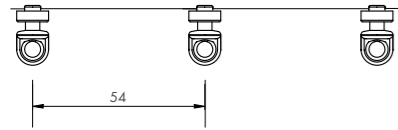

A13-121521-100 | mini wheeled wave fold carrier

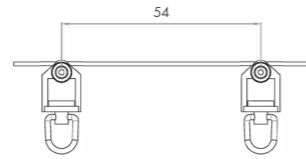

A13-SF200/100S | small wheeled wave fold carrier

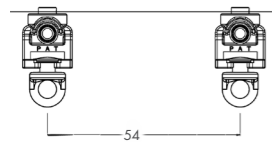

A13-SF200/100 | large wheeled wave fold carrier

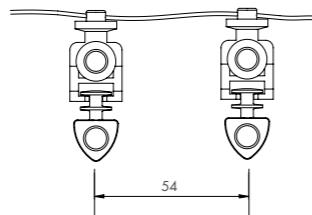

• all runners available in black and white

## TAPE

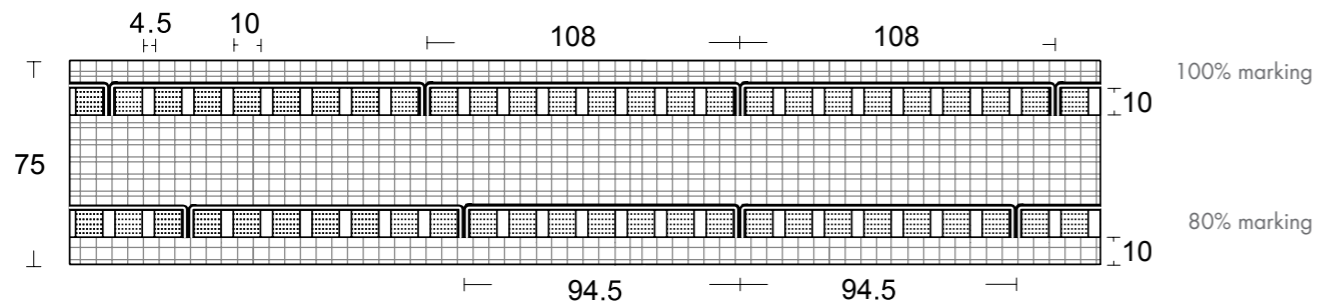

• available in transparent only

## WAVE DEPTH

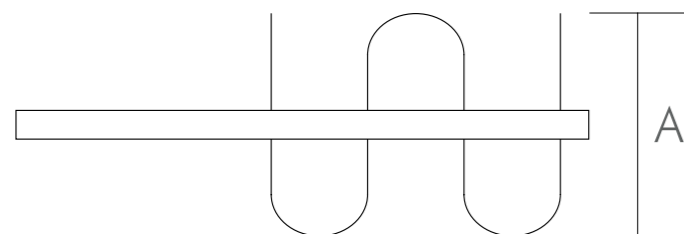

Maximum Wave Depth:  
 80% Fullness - A = 95mm  
 100% Fullness - A = 105mm  
 120% Fullness - A = 115mm



# WAVE FOLD DESIGNER 10

## PROFILE

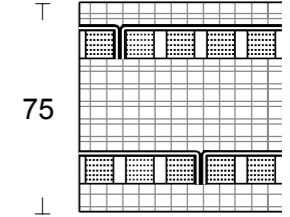
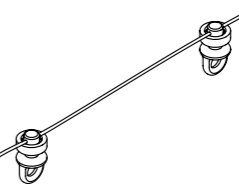
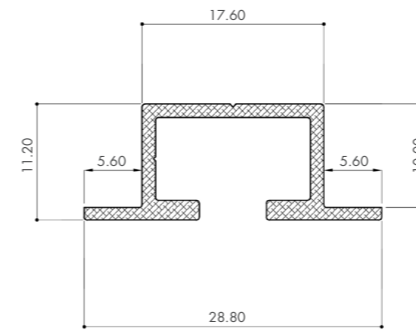

non-wheeled carrier

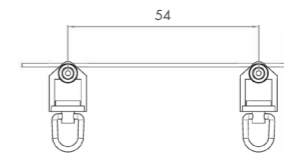

mini-wheeled carrier

Available in:  
 80% Fullness  
 100% Fullness  
 120% Fullness

## COLOURS AVAILABLE



White



Mill Finish (for Powdercoating)

## FIXING DETAILS

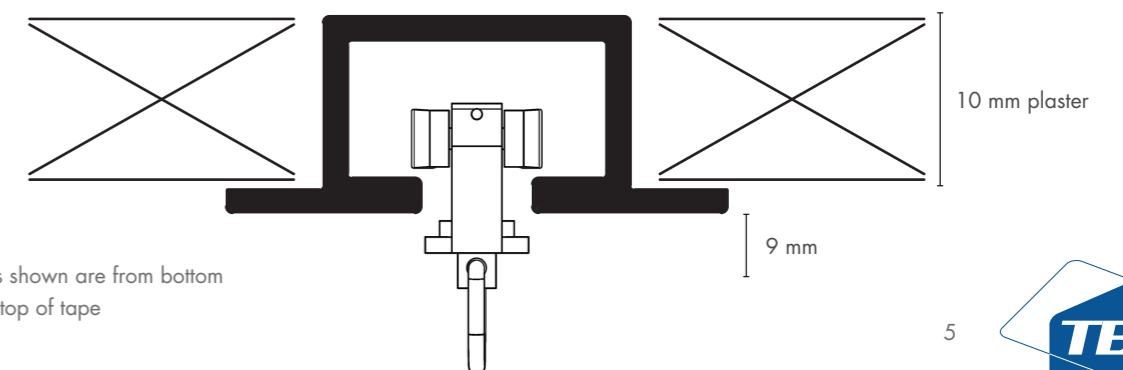
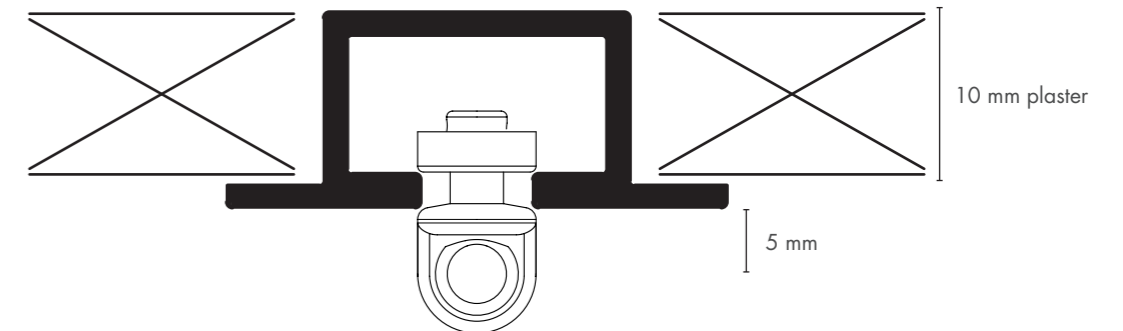

• Allowances shown are from bottom of track to top of tape



# WAVE FOLD DESIGNER 15

## PROFILE

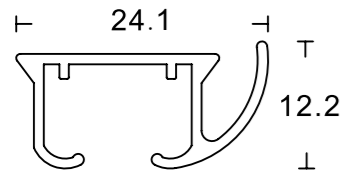

## RUNNERS & TAPE

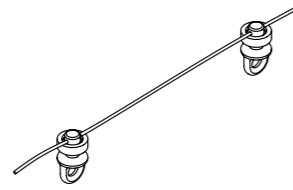

non-wheeled carrier

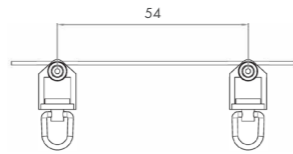
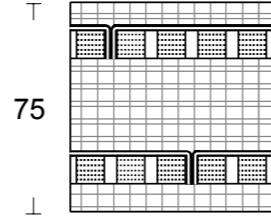

mini-wheeled carrier

Available in:  
80% Fullness  
100% Fullness  
120% Fullness

## COLOURS AVAILABLE



## FIXING DETAILS AND ALLOWANCES

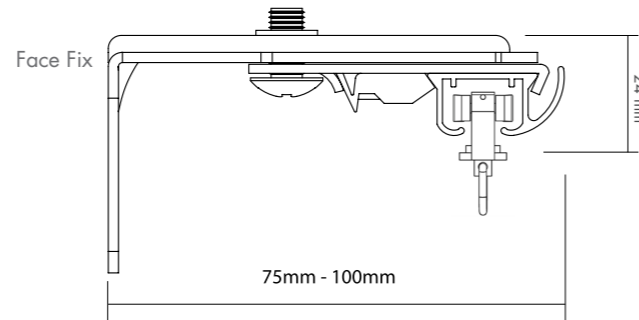
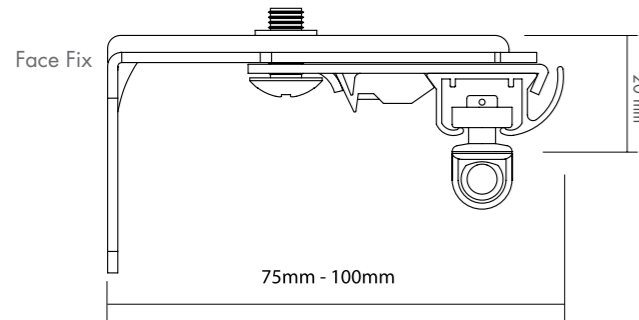
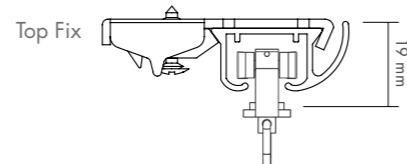
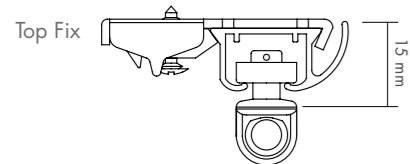

• Allowances shown are from top of the bracket to top of the tape



# WAVE FOLD SYSTEM 20

## PROFILE

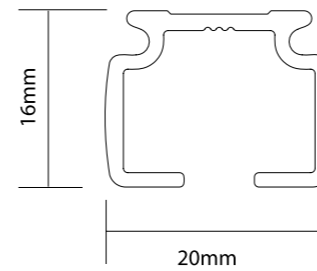

## RUNNERS & TAPE

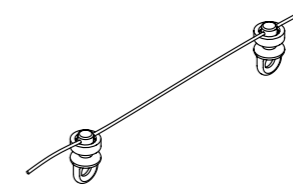

non-wheeled carrier

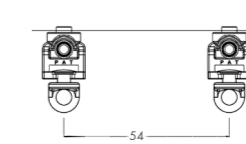
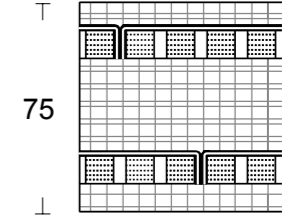

small wheeled wave fold carrier

Available in:  
80% Fullness  
100% Fullness  
120% Fullness

## COLOURS AVAILABLE

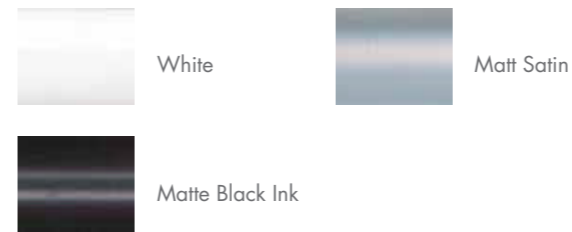

## BENDS



Continuous Bends



Angle Bends (up to 90 degrees)  
150 mm radius

## FIXING DETAILS AND ALLOWANCES

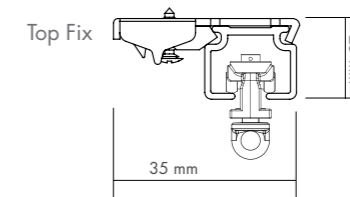
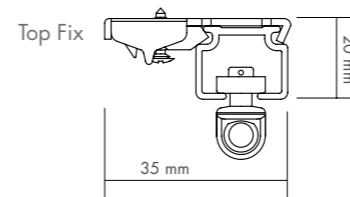

A - Single Face Fix 74-110mm  
B - Double Face Fix 115-150mm  
C - Triple Face Fix 200-240mm

• Allowances shown are from top of the bracket to top of the tape

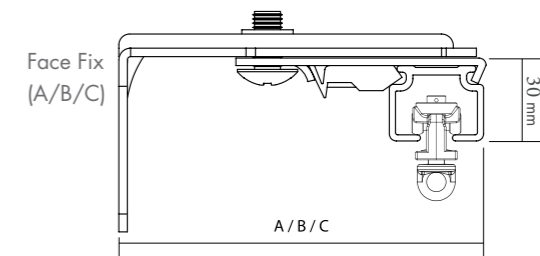
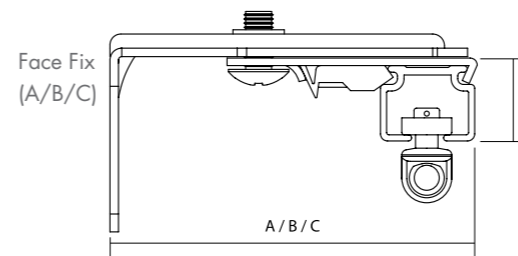



# WAVE FOLD DESIGNER 25

## PROFILE



## RUNNERS & TAPE

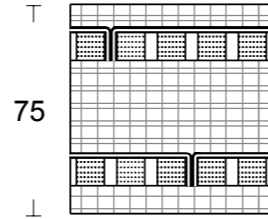
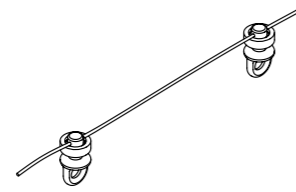

non-wheeled carrier



mini-wheeled carrier

Available in:  
80% Fullness  
100% Fullness  
120% Fullness

## COLOURS AVAILABLE



Gold



White



Matt Satin

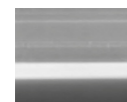

Chrome

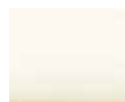

Birch White



Champagne



Antique Brass



Matte Black Ink

## BENDS

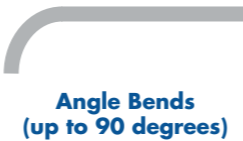

Angle Bends  
(up to 90 degrees)

## FIXING DETAILS AND ALLOWANCES

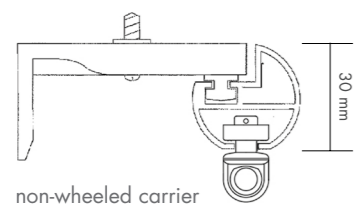

non-wheeled carrier

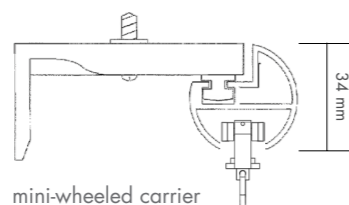

mini-wheeled carrier

- Allowances shown are from top of the bracket to top of the tape

Magnetic Covers Available

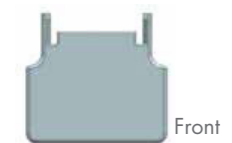

Front

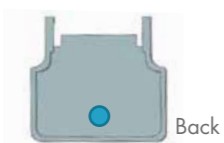

Back



Side

A1 - GT355C - BL/BW/MS/WH

Colours Available:

- White
- Birch White
- Black
- Matt Satin
- Champagne



# WAVE DESIGNER 25

## FINIALS

## CODE

## DESCRIPTION



G0-EC25

25mm END CAP  
Available in Antique Brass, Matte Black Ink, Birch, Chrome, Gold, Matt Satin, White, Champagne



G0-EC25/1

25mm PYRAMID END CAP  
Available in Antique Brass, Matte Black Ink, Birch, Chrome, Gold, Matt Satin, White



G0-DF25/3

25mm BALL FINIAL  
Available in Antique Brass, Matte Black Ink, Birch, Chrome, Gold, Matt Satin, White



G0-EC25/5

25mm MUSHROOM FINIAL  
Available in Antique Brass, Matte Black Ink, Birch, Chrome, Champagne, Gold, Matt Satin, White



# WAVE FOLD DESIGNER 38

## PROFILE

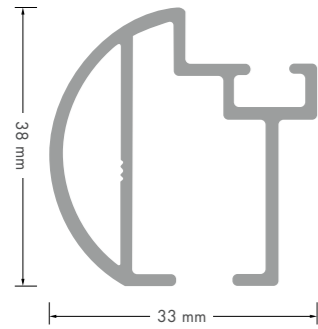

## RUNNERS & TAPE

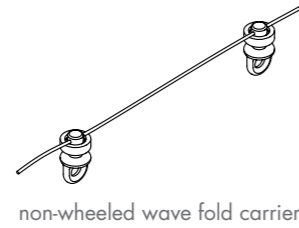

non-wheeled wave fold carrier

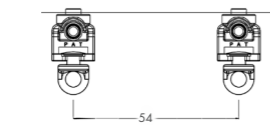

small wheeled wave fold carrier

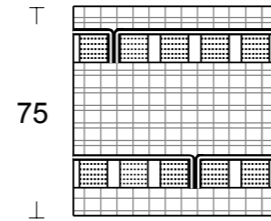

Available in:  
80% Fullness  
100% Fullness  
120% Fullness

## COLOURS AVAILABLE

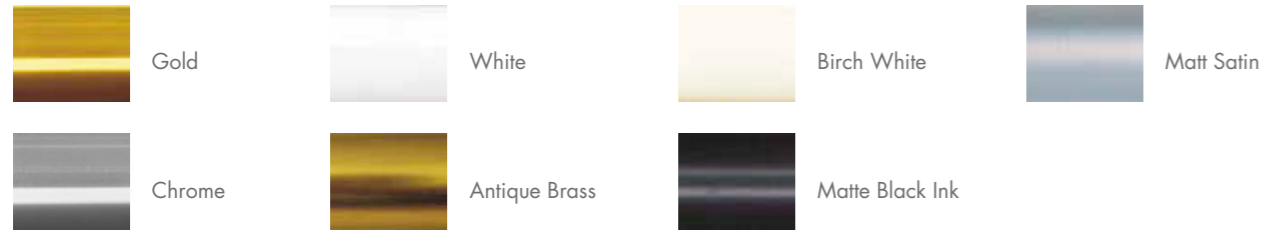

## FIXING DETAILS AND ALLOWANCES

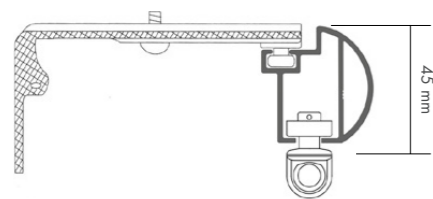

non-wheeled wave fold carrier

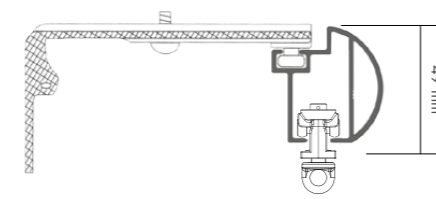

small wheeled wave fold carrier

• Allowances shown are from top of the bracket to top of the tape

Magnetic Covers Available

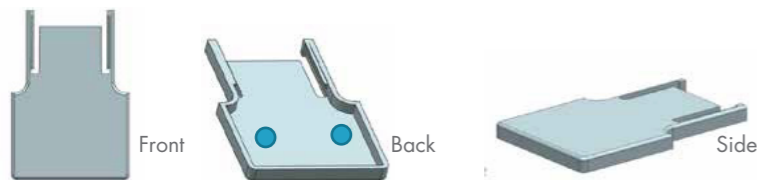

A6 - GTD355C - AB/BL/BW/G/WH

Colours Available:  
• White • Matt Silver  
• Birch White • Gold  
• Black • Antique



# WAVE FOLD DESIGNER 38

## FINIALS

## CODE

## DESCRIPTION

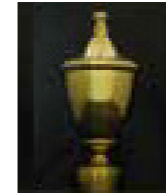

A5-GTD387

METAL CLASSIC FINIAL  
Available in Antique Brass, Gold, Chrome, White, White Birch, Matte Black Ink, Matt Satin



A5-GTD388

METAL BALL FINIAL  
Available in Antique Brass, Gold, Chrome, White, White Birch, Matte Black Ink, Matt Satin



A5-GTD385

PLASTIC BALL FINIAL  
Available in Antique Brass, Gold, Chrome, White, White Birch, Black, Matt Satin



A5-GTD384

PLASTIC CLASSIC FINIAL  
Available in Antique Brass, Gold



A5-GTD383

PLASTIC PARISIAN FINIAL  
Available in Antique Brass, Gold, Chrome, White, White Birch, Black, Matt Satin



D0-BR38

38mm PLATED BRASS END CAP  
Available in Antique Brass, Matte Black Ink, White, Chrome, Birch White, Gold, and Matt Satin



D0-FIL38

38mm FILIGREE FINIAL  
Available in Antique Brass, Gold, Chrome, Matt Satin



# WAVE FOLD MOTORISATION

## PROFILE

## RUNNERS & TAPE

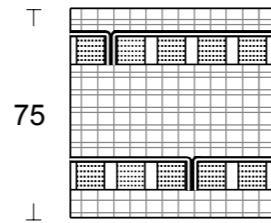
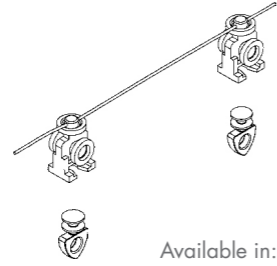
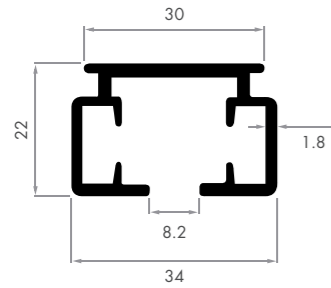

Available in:  
80% Fullness  
100% Fullness  
120% Fullness

## COLOURS AVAILABLE



## BENDS

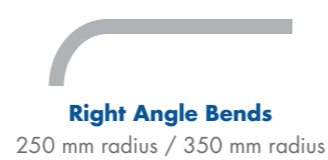

## FIXING DETAILS AND ALLOWANCES

Top Fix

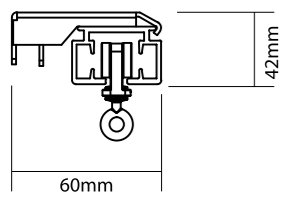

Single Face Fix

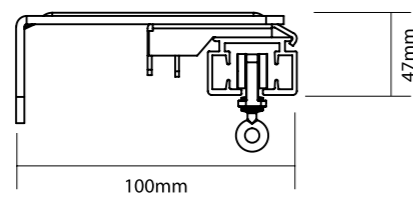

Single Track Double Bracket

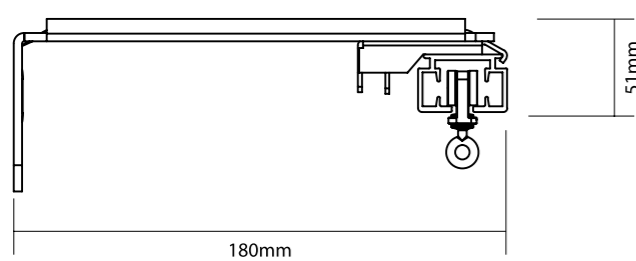

• Allowances shown are from top of the bracket to top of the tape



# WAVE FOLD HEAVY DUTY

## PROFILE

## RUNNERS & TAPE

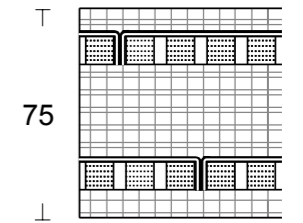
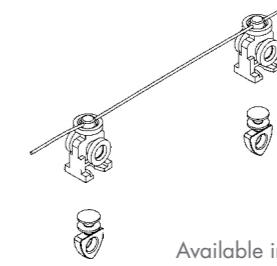
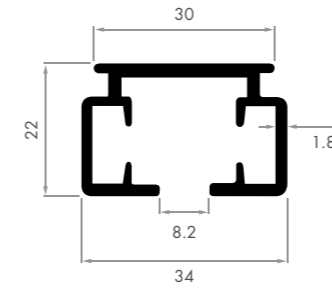

Available in:  
80% Fullness  
100% Fullness  
120% Fullness

## COLOURS AVAILABLE



## BENDS

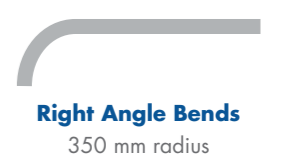

## FIXING DETAILS AND ALLOWANCES

Top Fix

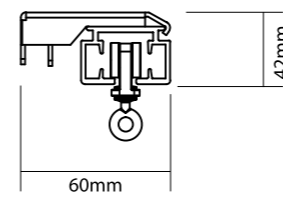

Single Face Fix

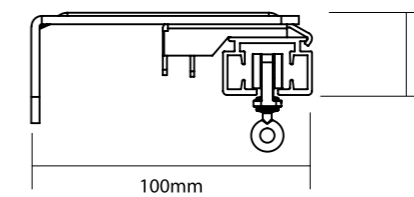

Single Track Double Bracket

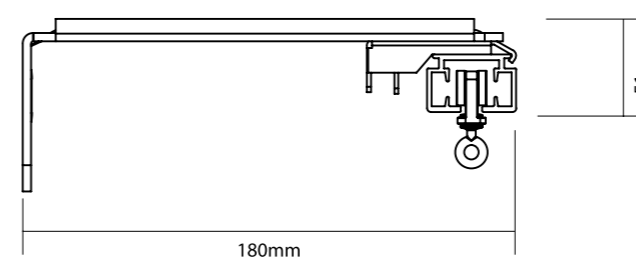

• Allowances shown are from top of the bracket to top of the tape

## SUSPENDED APPLICATION

Available as Suspended Application

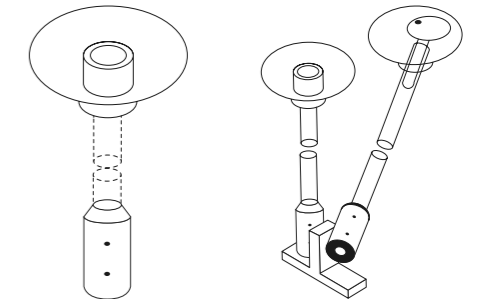







# S-FOLD

## STRING RUNNERS

Non-Wheeled Carrier

80% Fullness | A13-SF100/80S

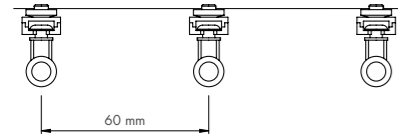

100% Fullness | A13-SF100/100S

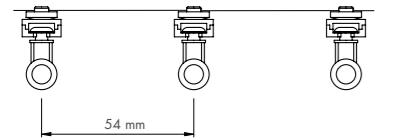

120% Fullness | A13-SF100/120S

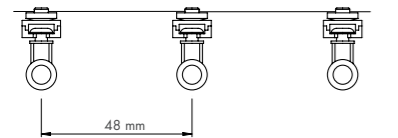

Small Wheeled Carrier

80% Fullness | A13-SF200/80S

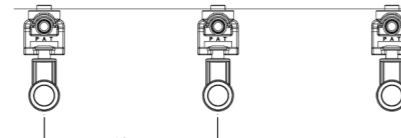

100% Fullness | A13-SF200/100S

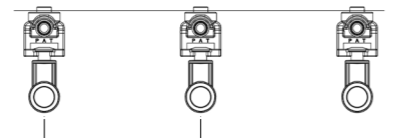

120% Fullness | A13-SF200/120S

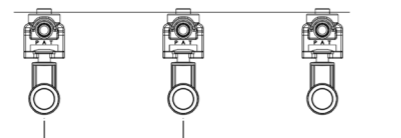

Large Wheeled Carrier

80% Fullness | A13-SF200/80S

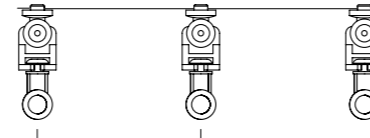

100% Fullness | A13-SF200/100S

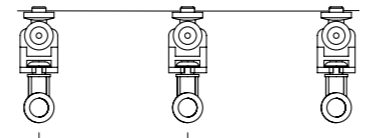

120% Fullness | A13-SF200/120S

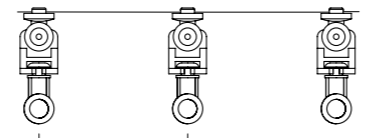

## TAPE

A13-SF425/25

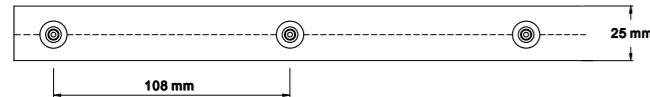

A13-SF425/50

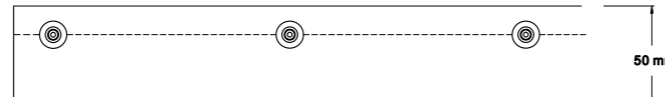

• All tapes available in White, Black & Transparent

## WAVE DEPTH

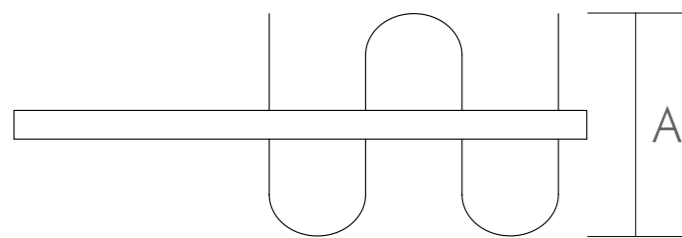

Maximum S Depth:

- 80% Fullness - A = 95mm
- 100% Fullness - A = 95mm
- 120% Fullness - A = 95mm



# S-FOLD DESIGNER 10

## PROFILE

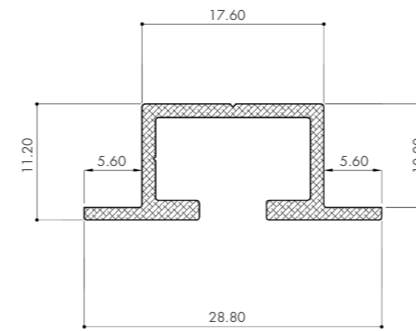

## RUNNERS & TAPE

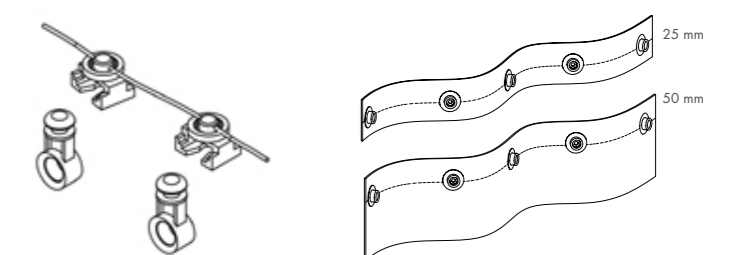

Available in:  
 80% Fullness = 60mm Spacing  
 100% Fullness = 54mm Spacing  
 120% Fullness = 48mm Spacing

108mm Spacing Between Studs  
 Available in:  
 White, Black & Transparent

## COLOURS AVAILABLE



White



Mill Finish (for Powdercoating)

## FIXING DETAILS

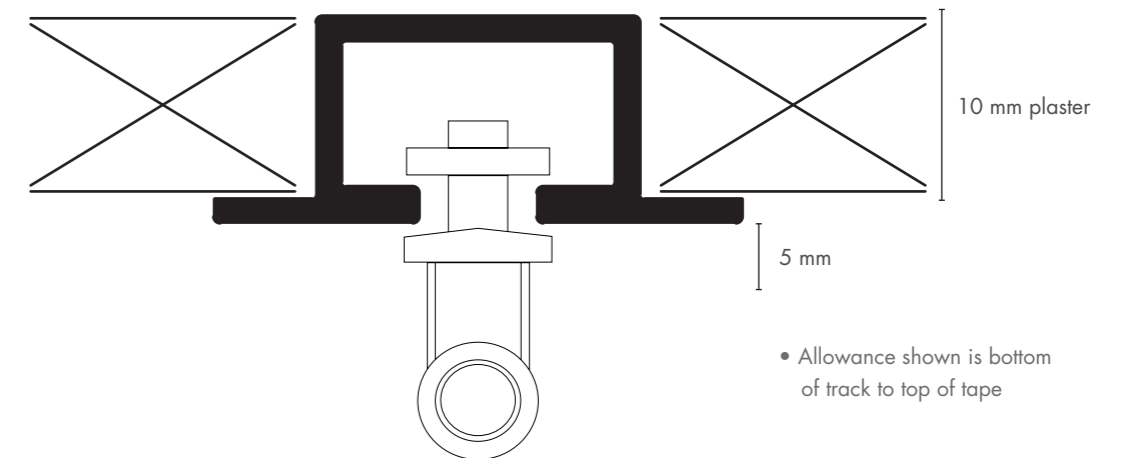

• Allowance shown is bottom of track to top of tape



# S-FOLD DESIGNER 15

## PROFILE

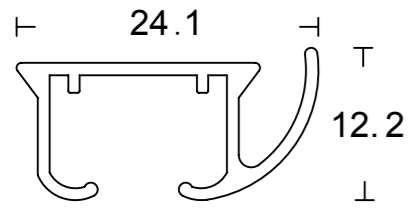

## RUNNERS & TAPE

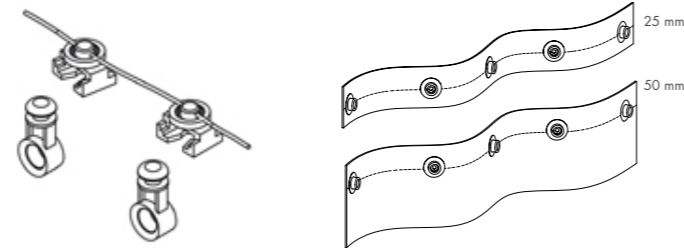

Available in:  
 80% Fullness = 60mm Spacing  
 100% Fullness = 54mm Spacing  
 120% Fullness = 48mm Spacing

108mm Spacing Between Studs  
 Available in:  
 White, Black & Transparent

## COLOURS AVAILABLE



## FIXING DETAILS AND ALLOWANCES

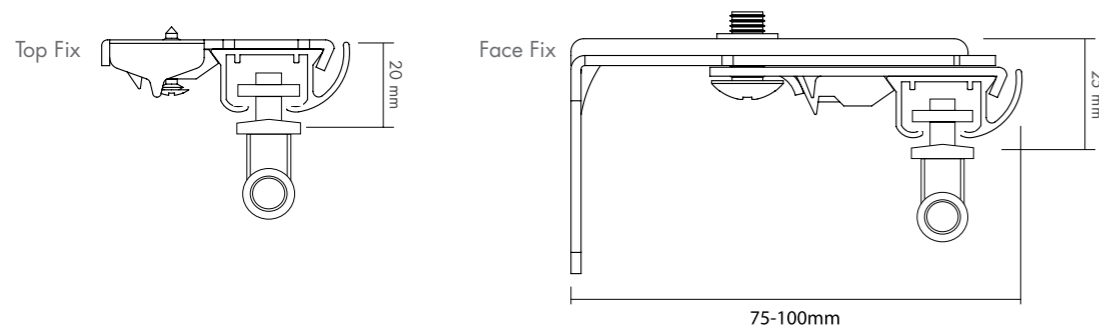

• Allowances shown are from top of track to top of tape



# S-FOLD SYSTEM 20

## PROFILE

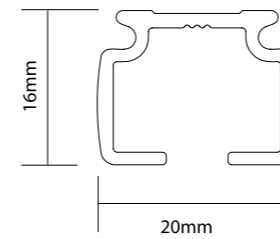

## RUNNERS & TAPE

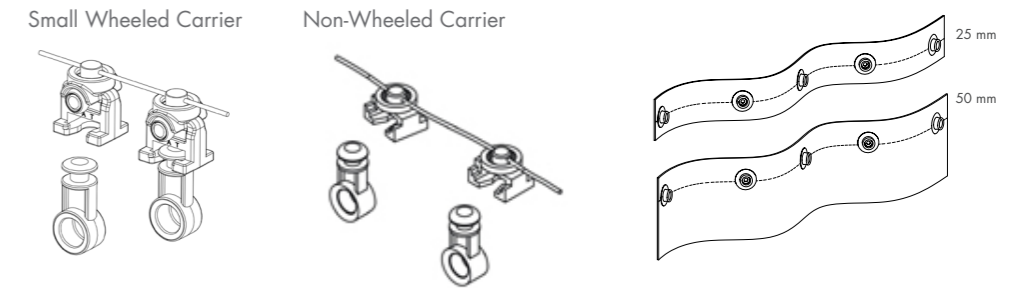

Available in:  
 80% Fullness = 60mm Spacing  
 100% Fullness = 54mm Spacing  
 120% Fullness = 48mm Spacing

108mm Spacing Between Studs  
 Available in:  
 White, Black & Transparent

## COLOURS AVAILABLE

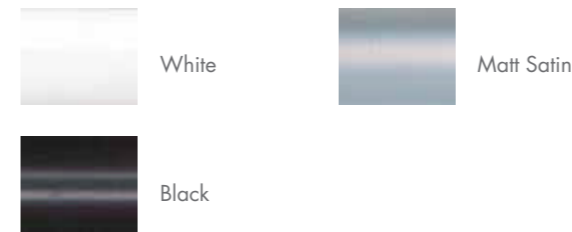

## BENDS



## FIXING DETAILS AND ALLOWANCES

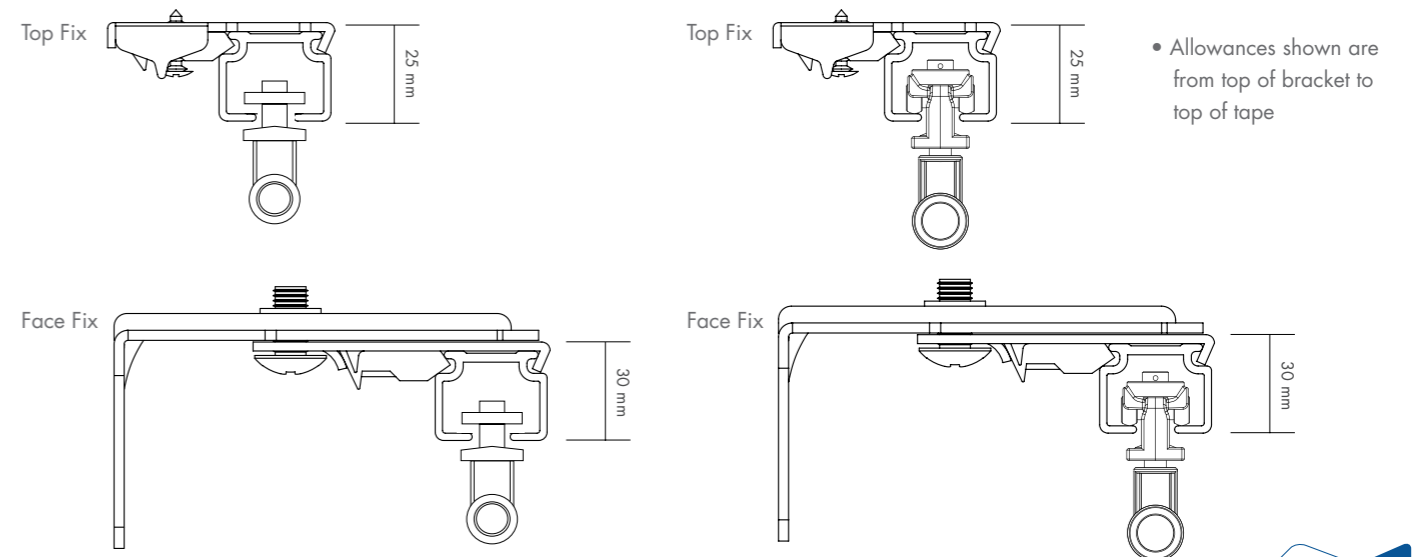

# S-FOLD DESIGNER 25

## PROFILE



## RUNNERS & TAPE

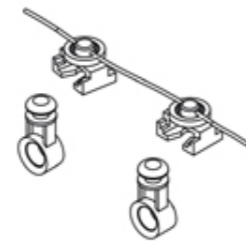

Available in:  
 80% Fullness = 60mm Spacing  
 100% Fullness = 54mm Spacing  
 120% Fullness = 48mm Spacing

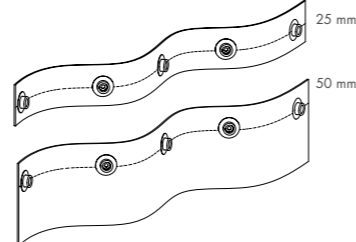

108mm Spacing Between Studs

Available in:  
 White, Black & Transparent

## COLOURS AVAILABLE

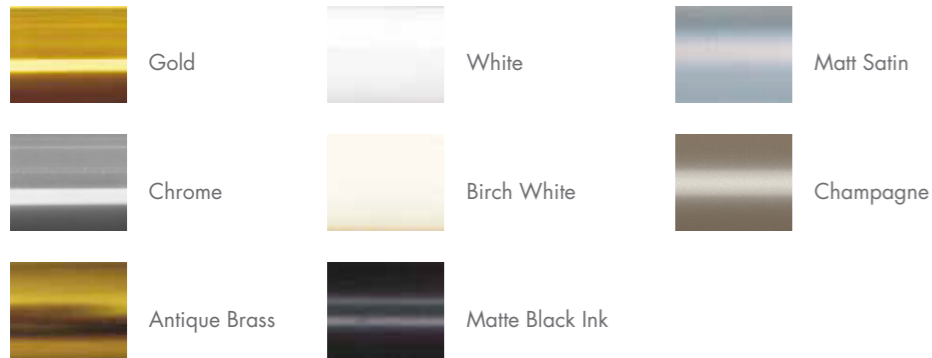

## BENDS

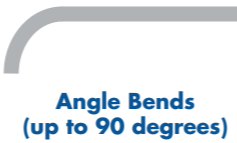

## FIXING DETAILS AND ALLOWANCES

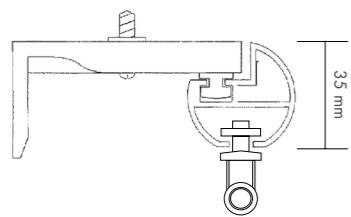

• Allowances shown are from top of track to top of tape

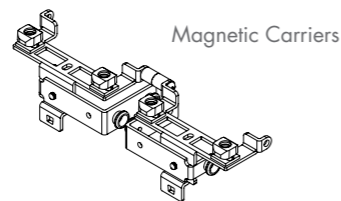

Magnetic Carriers

A1 - GT355C - BL/BW/MS/WH

Colours Available:

- White
- Birch White
- Black
- Matt Satin
- Champagne

Magnetic Covers Available

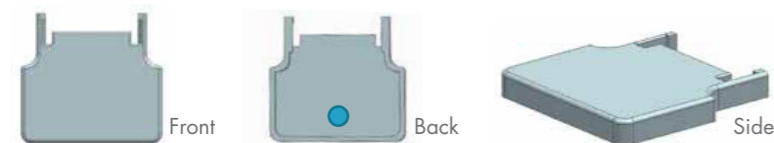

# S-FOLD DESIGNER 25

## FINIALS

## CODE

## DESCRIPTION



G0-EC25

25mm END CAP  
 Available in Antique Brass, Matte Black Ink, Birch, Chrome, Gold, Matt Satin, White, Champagne



G0-EC25/1

25mm PYRAMID END CAP  
 Available in Antique Brass, Black, Birch, Chrome, Gold, Matt Satin, White



G0-DF25/3

25mm BALL FINIAL  
 Available in Antique Brass, Matte Black Ink, Birch, Chrome, Gold, Matt Satin, White



G0-EC25/5

25mm MUSHROOM FINIAL  
 Available in Antique Brass, Matte Black Ink, Birch, Chrome, Champagne, Gold, Matt Satin, White





# S-FOLD DESIGNER 38

## PROFILE

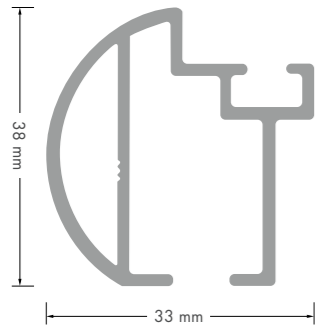

## RUNNERS & TAPE

Small Wheeled Carrier

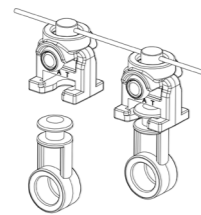

Non-Wheeled Carrier

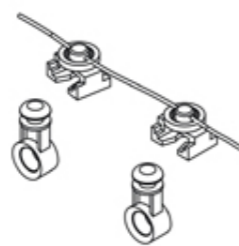

Available in:  
80% Fullness = 60mm Spacing  
100% Fullness = 54mm Spacing  
120% Fullness = 48mm Spacing

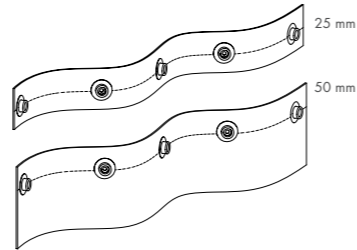

108mm Spacing Between Studs

Available in:  
White, Black & Transparent

## COLOURS AVAILABLE

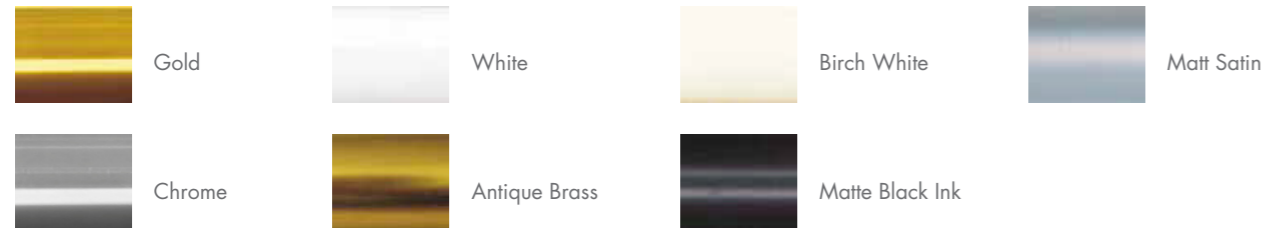

## FIXING DETAILS AND ALLOWANCES

small wheeled carrier

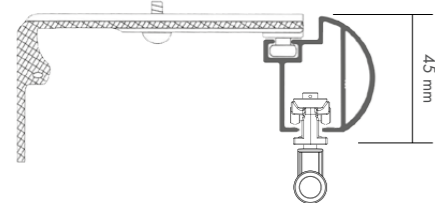

non-wheeled carrier

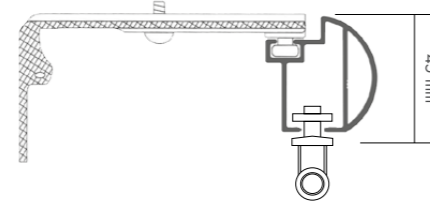

• Allowances shown are from top of the bracket to top of the tape

Magnetic Covers Available

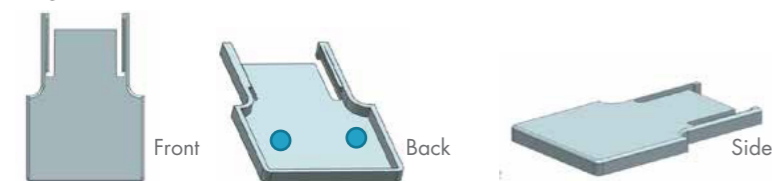

A6 - GTD355C - AB/BL/BW/G/WH

Colours Available:  
• White • Matt Silver  
• Birch White • Gold  
• Black • Antique

# S-FOLD DESIGNER 38

## FINIALS

## CODE

## DESCRIPTION

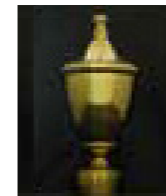

A5-GTD387

METAL CLASSIC FINIAL  
Available in Antique Brass, Gold, Chrome, White, White Birch, Matte Black Ink, Matt Satin



A5-GTD388

METAL BALL FINIAL  
Available in Antique Brass, Gold, Chrome, White, White Birch, Matte Black Ink, Matt Satin



A5-GTD385

PLASTIC BALL FINIAL  
Available in Antique Brass, Gold, Chrome, White, White Birch, Black, Matt Satin



A5-GTD384

PLASTIC CLASSIC FINIAL  
Available in Antique Brass, Gold



A5-GTD383

PLASTIC PARISIAN FINIAL  
Available in Antique Brass, Gold, Chrome, White, White Birch, Black, Matt Satin



D0-BR38

38mm PLATED BRASS END CAP  
Available in Antique Brass, Matte Black Ink, White, Chrome, Birch White, Gold, and Matt Satin



D0-FIL38

38mm FILIGREE FINIAL  
Available in Antique Brass, Gold, Chrome, Matt Satin



# S FOLD MOTORISATION

## PROFILE

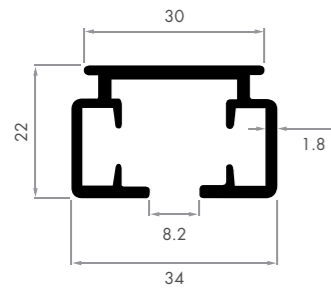

## RUNNERS & TAPE

### Wheeled runner



Available in:  
 80% Fullness = 60mm Spacing  
 100% Fullness = 54mm Spacing  
 120% Fullness = 48mm Spacing

### Tape

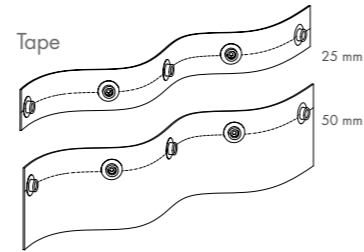

108mm Spacing Between Studs

Available in:  
 White, Black & Transparent

## COLOURS AVAILABLE



White



Black



Continuous Bends



Right Angle Bends

250 mm radius / 350 mm radius

## FIXING DETAILS AND ALLOWANCES

### Top Fix

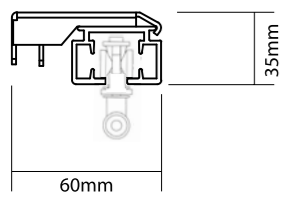

### Single Face Fix

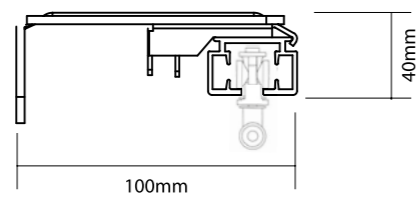

### Single Track Double Bracket

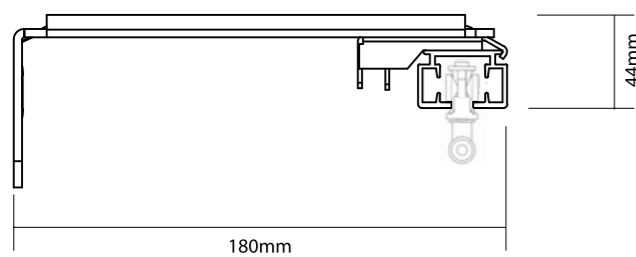

• Allowances shown are from top of the bracket to top of the tape



# S-FOLD HEAVY DUTY

## PROFILE

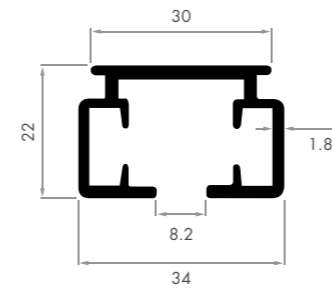

## RUNNERS & TAPE

### Wheeled runner



Available in:  
 80% Fullness = 60mm Spacing  
 100% Fullness = 54mm Spacing  
 120% Fullness = 48mm Spacing

### Tape

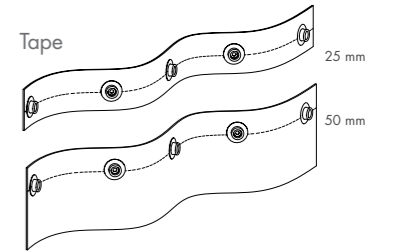

108mm Spacing Between Studs

Available in:  
 White, Black & Transparent

## COLOURS AVAILABLE



White



Black



Continuous Bends



Right Angle Bends

350 mm radius

## FIXING DETAILS AND ALLOWANCES

### Top Fix

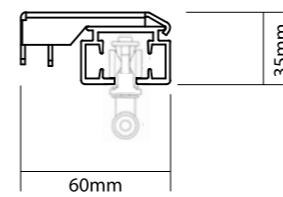

### Single Face Fix

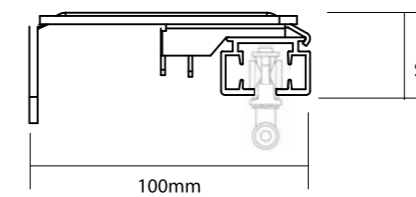

### Available as Suspended Application

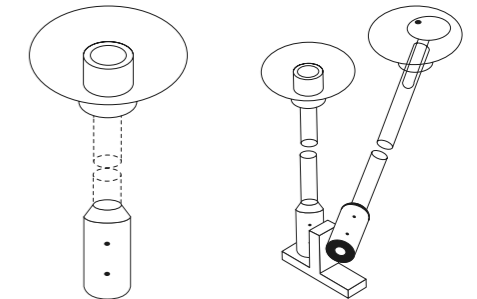

### Single Track Double Bracket

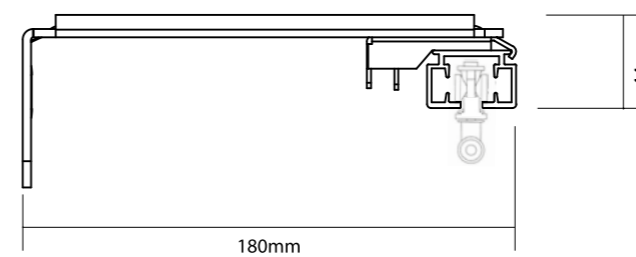

• Allowances shown are from top of the bracket to top of the tape



# PELMET / BULKHEAD

## Allowances for Bent Tracks

S-Fold / Wave Fold (excluding motor)

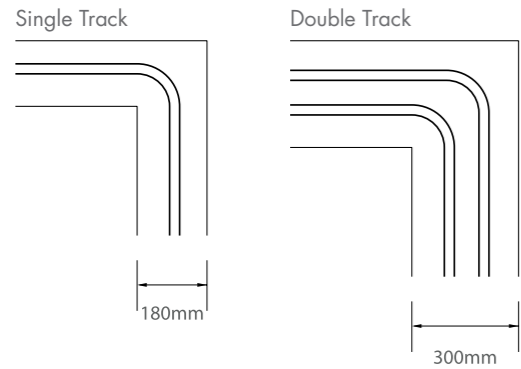

Saber Motor S-Fold / Wave Fold Streamline

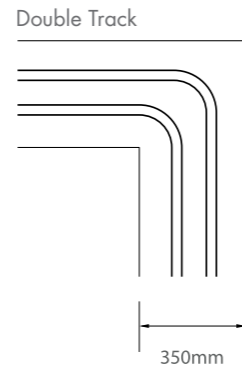

Saber Motor S-Fold / Wave Fold System 20

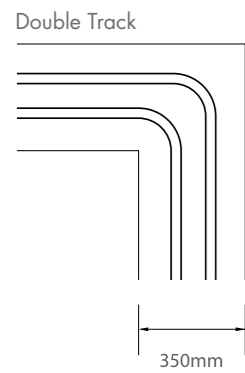

Saber Motor S-Fold / Wave Fold Saber Motor Standard Runners

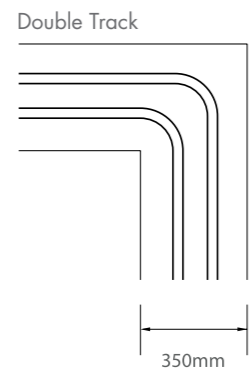

Saber Motor S-Fold / Wave Fold Saber Motor S-Fold / Wave Fold

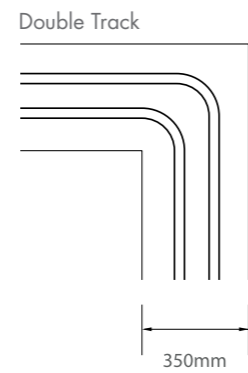

- Streamline - R = 150mm
- System 20 - R = 150mm
- Designer 25 - R = 150mm
- Saber Motor - R = 250mm & 350mm



# BRACKET COVERS

**Designer 15**

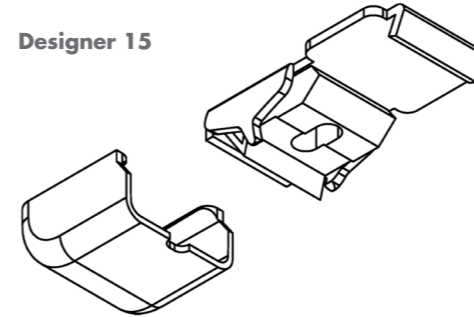

**System 20**

Magnetic Covers Available

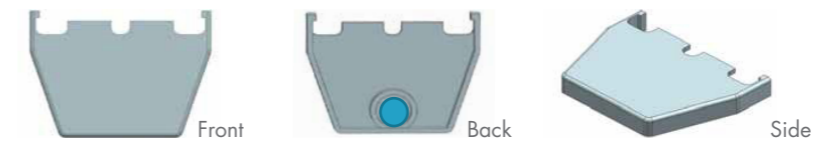

**Designer 25 / Streamline**

Magnetic Covers Available

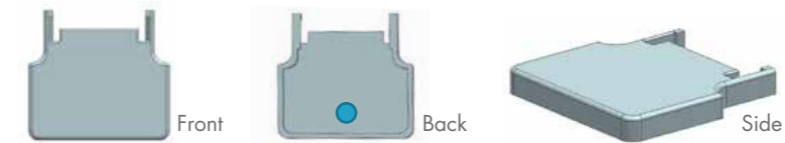

**Designer 38**

Magnetic Covers Available

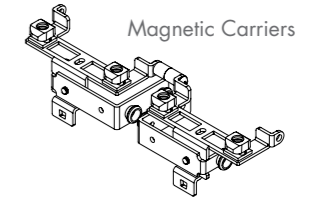
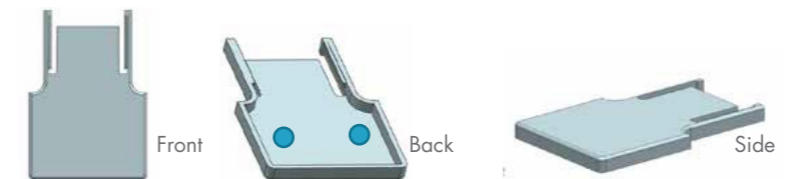

- For use with:
- System 20
  - Designer 25

A1-GT3855C - BL/MS/WH

- Colours Available:
- White
  - Black
  - Matt Silver

A1 - GT355C - BL/BW/MS/WH

- Colours Available:
- White
  - Birch White
  - Black
  - Matt Satin
  - Champagne

A6 - GTD355C - AB/BL/BW/G/WH

- Colours Available:
- White
  - Birch White
  - Black
  - Matt Silver
  - Gold
  - Antique







**TBS (Aust) Pty. Ltd.**  
1/16 Metrolink Circuit, Campbellfield  
Melbourne, Australia 3061  
**P** +61 3 8339 2660  
**F** +61 3 8339 2663  
**E** [sales@tbsaust.net.au](mailto:sales@tbsaust.net.au)

**CONTACT YOUR AUTHORISED STOCKIST**

