

SABER

C U R T A I N M O T O R S

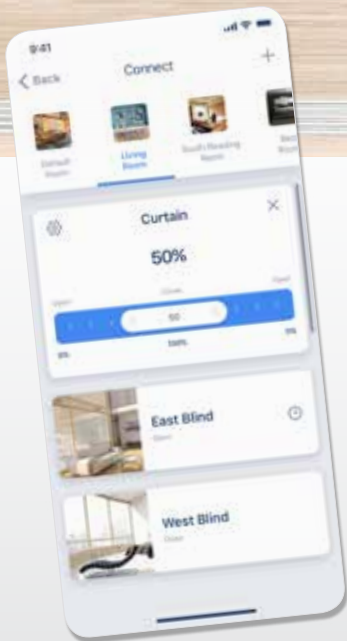



SABER

CURTAIN MOTORS

Contents

Smart Hub / Shade Connector	4-5
Saber 100 EN/S Curtain Motor	6-7
Saber 50 LQ/S Curtain Motor	8-9
Saber 75 Home Automation	10-11
Controls	12
Pelmet & Bulkhead Allowances	13
Installation & Technical Specifications	14-15



TBS (Aust) Pty Ltd is an Australian owned and operated company which imports, wholesales and provides a made to measure service to the window covering industry. TBS has a focus on working alongside some of Australia's largest architects, developers, commercial and high street retailers with a view to being able to offer a full suite of products for any type of development.

TBS continues to look for a competitive advantage realising that many architects and end users want to make a statement with their window furnishings. TBS offers the ability to provide custom made solutions for Motorised Curtains and Blinds, Roller Blinds, Aluminium and Timber Venetian Blinds, Pole Sets, Panel Tracks, Vertical Blinds and an extensive range of curtain tracking systems including applications for residential homes, hospitals, aged care, psychiatric wards, theatres and hotel developments.

With this philosophy TBS has expanded to have distributorship or representation in South Australia, Western Australia, New South Wales and Queensland with the market being serviced from our customer service centre in Melbourne and warehouses in Melbourne, Sydney and Brisbane.





SMART HUB



The TBS Smart Home Hub is a WiFi to radio frequency controller with an integrated RS485 interface. It builds a connection via the users WiFi router and enables the user to control motorised window coverings with a designated smartphone app.

It also allows interaction with ecosystems such as Google Home, Amazon Echo (Alexa) and IFTTT. The RS485 interface offers additional integration into third party home automation systems.



- OK Google, Start my day
- OK Google, Open blind to 20%
- Ok Google, Turn on scene
- OK Google, Good night

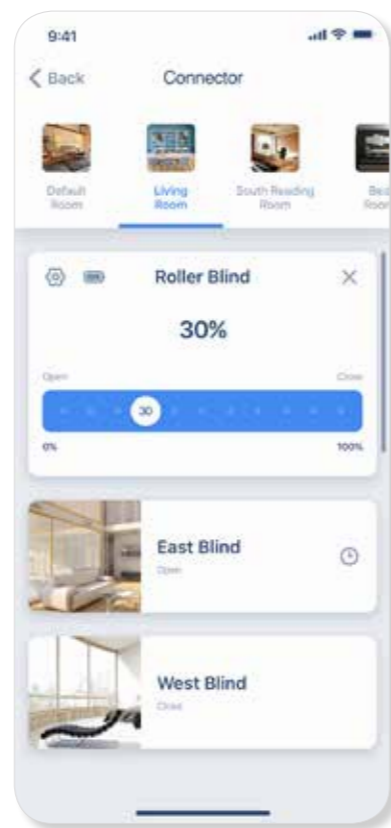
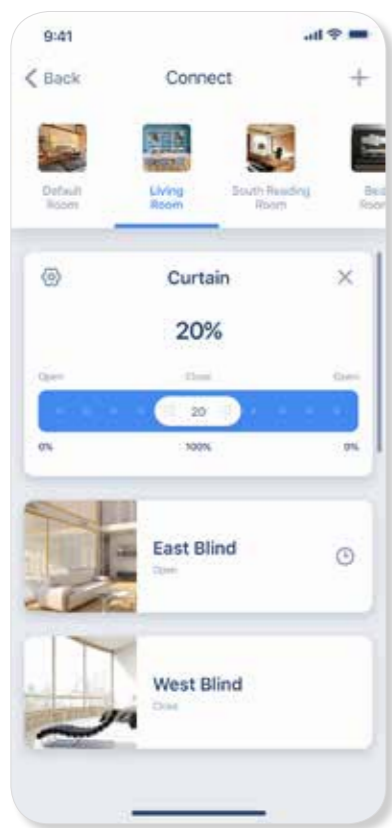

SMART Hub

Step 1 Download APP

Please scan below QR code.



Step 2

Please scan the QR code below to access our 'How To' instructions on YouTube.



NATIVE SIRI INTEGRATION

"Siri, close bedroom curtain."
Simple as that.
* For iOS12 or above only.



- Alexa, Start my day
- Alexa, Turn on scene
- Alexa, Open curtain to 50%
- Alexa, Good night.

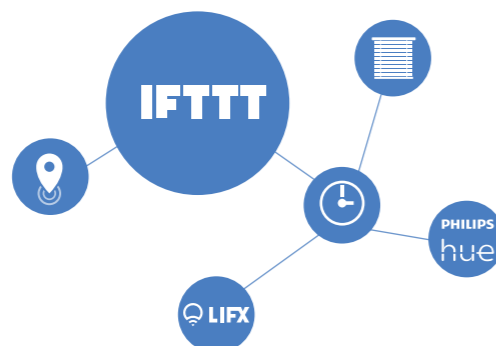



SABER 100 EN/S

BI-DIRECTION CURTAIN MOTOR

Strength & comfort unite with one touch...

The newly developed TBS Saber100 AC curtain motor boasts whisper quiet functionality and remarkable operating power with a capacity of 100kg whilst only weighing 1.1kg.



Smart Home Compatible



TBS1802
More Controls
Available on
Page 12

Available Bends

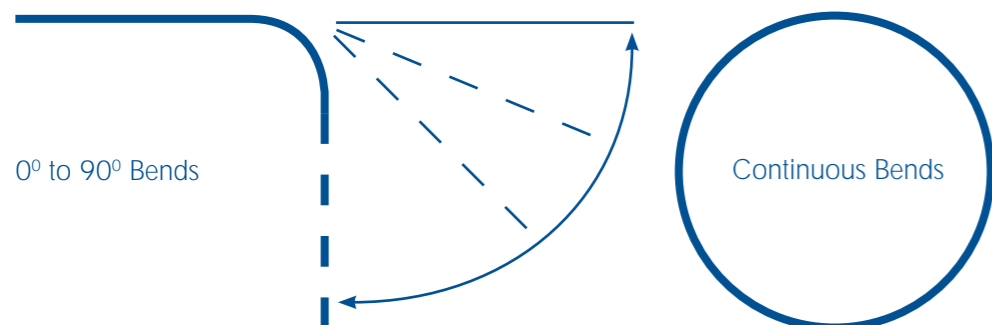

Load

Safe Curtain Weight:

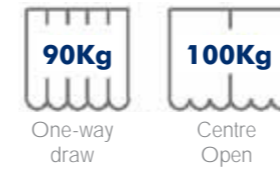

Headings

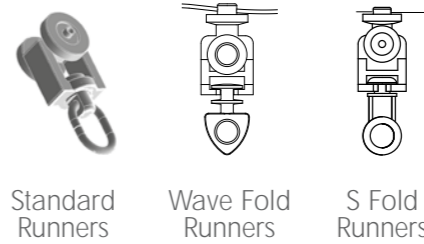

Wiring Kits

Standard Kit

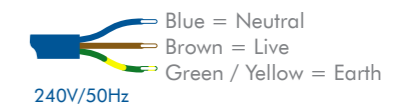

- Smart Home Compatible
- Electronic Limits
- Manual Limit Setting
- Third Limit Setting
- Touch Start
- Manual Override
- Reverse Direction from Remote

DRY CONTACT COMPATIBLE

Dry Contact Plug

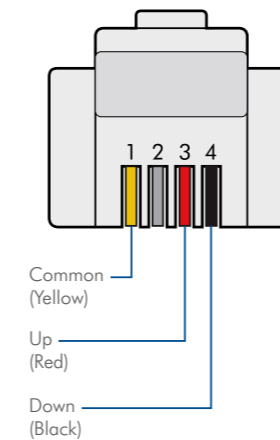

Underside Of Motor

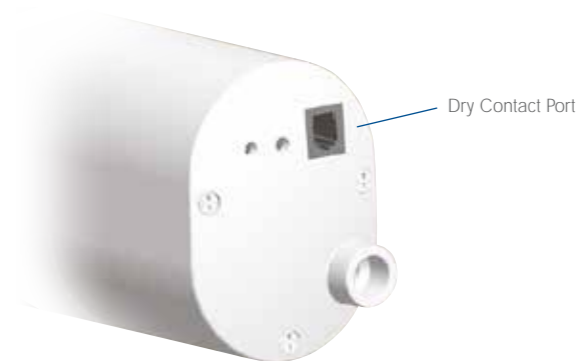

Technical Data	Safety Curtain Weight (KG)	Rated Input Power (W)	Open/Close Speed (cm/sec)	Input Rated Voltage (VAC)	Frequency (Hz)	Rated Current (A)	Running Time (min)	Protection Class (IP)	Maximum Range of Revolutions (Turn)	Track Length (m)	Weight (kg)
240V / 50Hz											
TBS100 EN/S	100	75	20	240	50	0.74	4	20	∞	«12	1.10

Product Certificate



SABER 50 LQ/S

LITHIUM BATTERY
BI-DIRECTION CURTAIN MOTOR



Load

Safe Curtain Weight:



One-way draw



Centre Open

Headings



Standard Runners

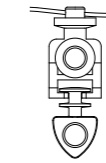

Wave Fold Runners

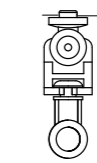

S Fold Runners

Detachable Battery



- No Expensive Wiring required
- Super Quiet 35dB operating noise
- 50kg Load Capacity
- 3rd Limit Function
- Dry Contact Compatibility
- Light Touch Start
- Manual Override
- Detachable Battery for easy charge
- 300 Open & Close Functions on one charge
- Horizontal or Vertical Motor Installation

Smart Home Compatible



Horizontal / Vertical Motor Fixing Option

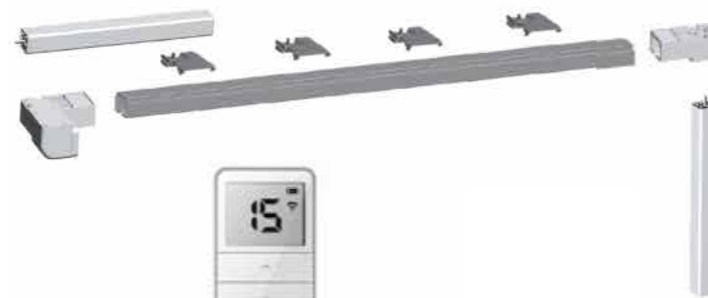

TBS1802
More Controls Available on Page 12

Available Bends

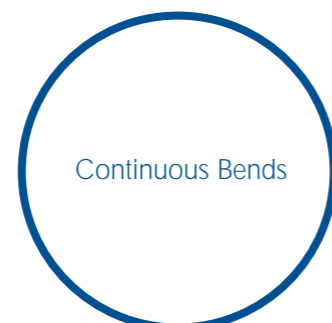
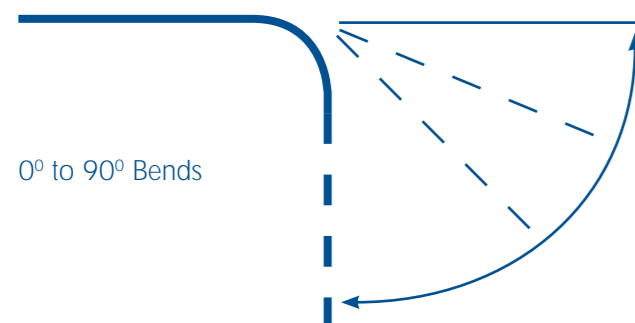

Dry Contact Plug

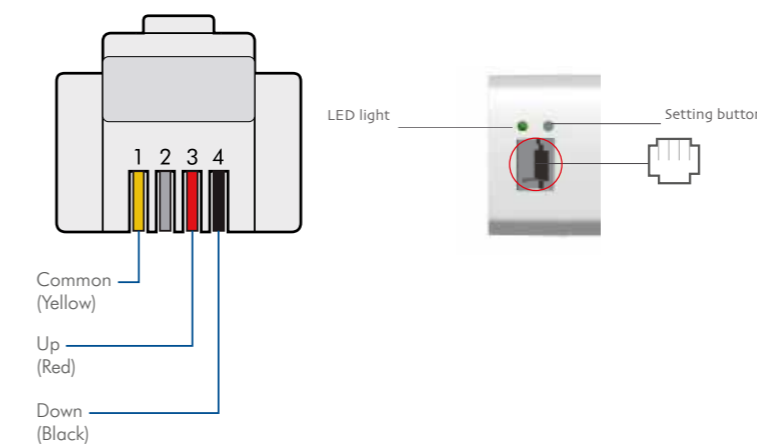

Horizontal Fixing Dimensions

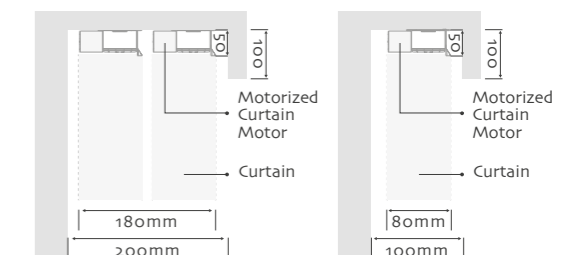

Technical Data	Safety Curtain Weight (KG)	Rated Input Power (W)	Open/Close Speed (cm/sec)	Input Rated Voltage (VAC)	Frequency (MHz)	Rated Current (A)	Running Time (min)	Protection Class (IP)	Maximum Range of Revolutions (Turn)	Track Length (m)	Weight (kg)
240V / 50Hz											
TBS50 LQ/S	50	50	14	14.8	433	0.8	4	20	∞	«12	1.10

Product Certificate



SABER 75



The ultimate Automation Integration System...

The TBS Saber75 AC Auto Integration motor is specifically designed to integrate with your home/office automation system allowing complete control of your window furnishings in conjunction with other electrical devices.



Electronic Limit

There is no longer any requirement to fiddle with unnecessary processes to set the limits. Limits are automatically set when resistance is met (i.e. fully closed or open).

Power off - Manual function

When the power is off, the manual function allows you to pull the curtain open or closed.

Resistance and stop function

If the curtain is in motion this function allows you to stop the curtain manually by hand. Also, if the curtain meets resistance the curtain will stop, all without affecting the limits.

Straight track or curved track

Both straight track and curved track are available to suit various applications and requirements.

One-way Draw or Centre Open

TBS Saber75 offers the option of either one-way draw or centre open which allows the flexibility and style to suit your requirements.

Available Bends

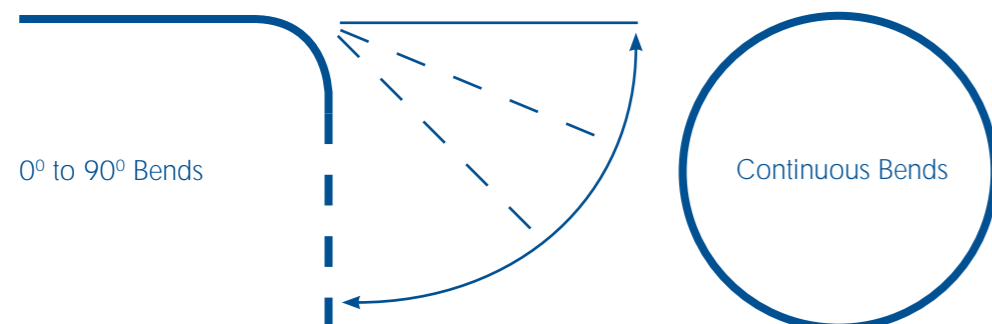

Load

Safe Curtain Weight:

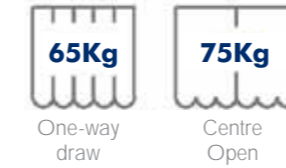

Headings

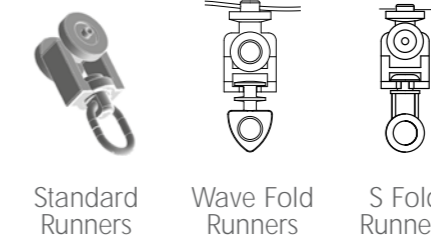

Wiring Kits

Standard Kit

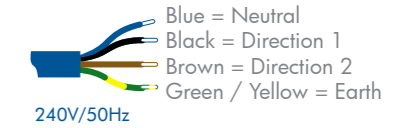

AUTOMATION INTEGRATION SYSTEM

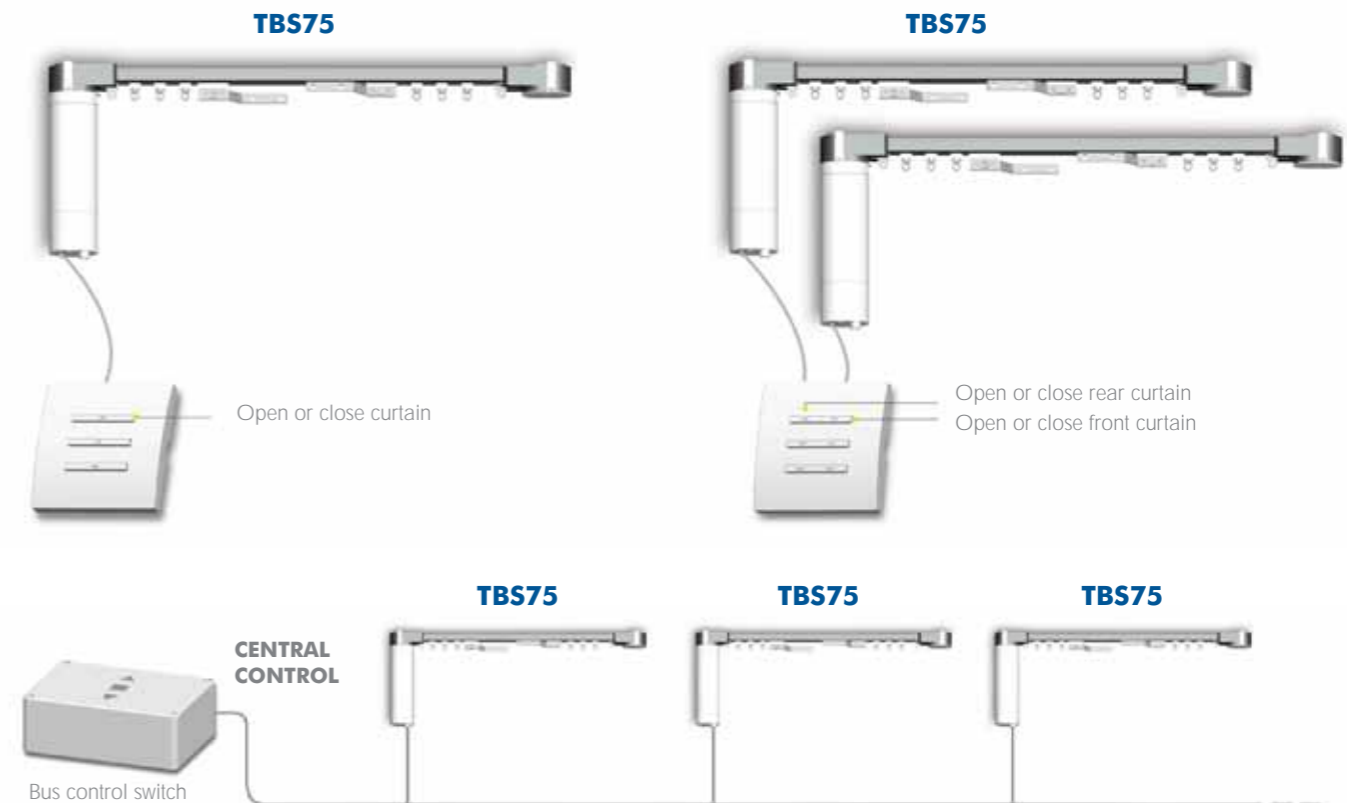

Technical Data	Safety Curtain Weight (KG)	Rated Input Power (W)	Open/Close Speed (cm/sec)	Input Rated Voltage (VAC)	Frequency (Hz)	Rated Current (A)	Running Time (min)	Protection Class (IP)	Maximum Range of Revolutions (Turn)	Track Length (m)	Weight (kg)
240V / 50Hz											
TBS75	75	75	20	240	50	0.74	4	20	∞	«12	1.10

Product Certificate



Control Systems

TBS Saber Control Systems ensure problem free operation of your motors allowing you to manage the comfort of your home or office with a touch of a button. They have been designed to suit any décor and are supplied with a discreet wall mounted holder which allows you to locate your hand held control with ease.

HAND HELD CONTROLS



TBS1800
Single channel emitter



TBS1802
15 channel wireless emitter

Features:

- Power: 3V 1 unit battery CR2450
- Battery usage life: > 3 Years
- Transmit Distance: Outdoor 200 mtrs
Indoor 35 mtrs
- Emitter Frequency: 433 MHz
- Emitter Power: 10mW
- Operating Temperature: -10°C - +50°C

- **Add and Remove channels to match the amount of motorised products**
- **Also available in Black**

WALL MOUNTED WIRELESS CONTROL



TBS770



TBS773

Features:

- Power: 3V 1 unit battery CR2450
- Battery usage life: > 3 Years
- Transmit Distance: Outdoor 200 mtrs
Indoor 35 mtrs
- Emitter Frequency: 433 MHz
- Emitter Power: 10mW
- Operating Temperature: -10°C - +50°C

- **Add and Remove channels to match the amount of motorised products**
- **Also available in Black**

PELMET / BULKHEAD Allowances for Bent Tracks

SABER MOTOR S-FOLD / WAVE FOLD STREAMLINE

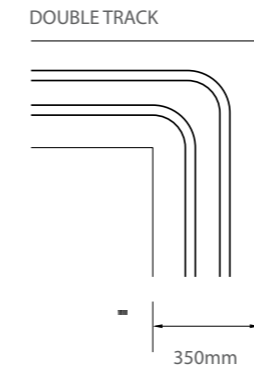

SABER MOTOR S-FOLD / WAVE FOLD SYSTEM 20

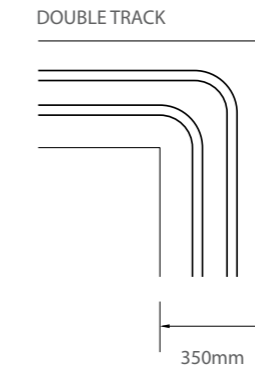

SABER MOTOR S-FOLD / WAVE FOLD SABER MOTOR S-FOLD / WAVE FOLD

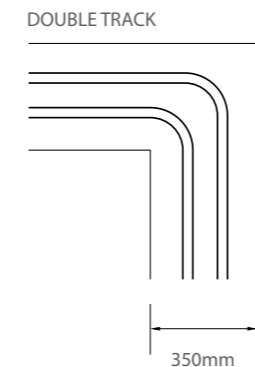

SABER MOTOR S-FOLD / WAVE FOLD SABER MOTOR STANDARD RUNERS

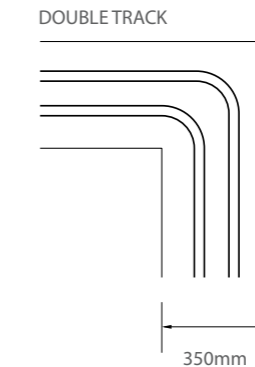

- STREAMLINE - R = 150mm
- SYSTEM 20 - R = 150mm
- DESIGNER 25 - R = 150mm
- SABER MOTOR - R = 250mm & 350mm

Installation & Technical Specifications

FIXING DETAILS & ALLOWANCES

STANDARD RUNNERS

TOP FIX

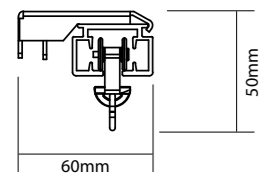

SINGLE FACE FIX

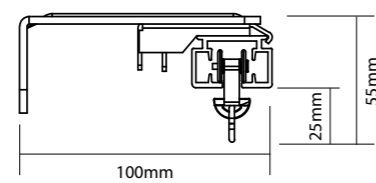

SINGLE TRACK DOUBLE BRACKET

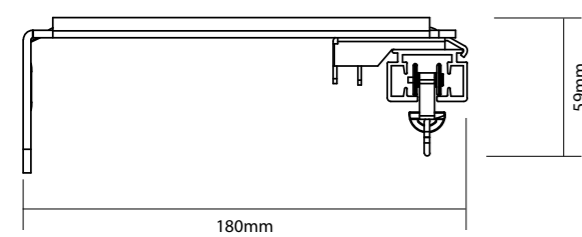

WAVE FOLD RUNNERS

TOP FIX

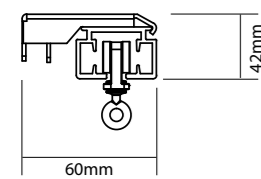

SINGLE FACE FIX

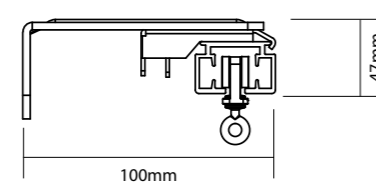

SINGLE TRACK DOUBLE BRACKET

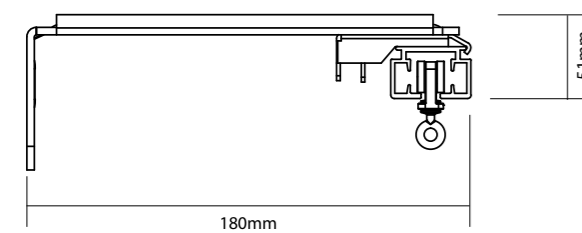

Available in: -
80% Fullness
100% Fullness
120% Fullness

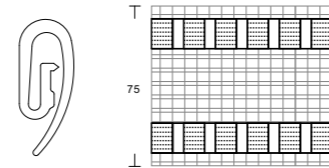
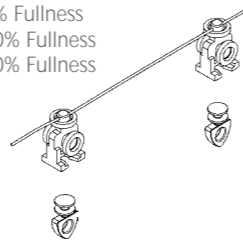

S FOLD RUNNERS

TOP FIX

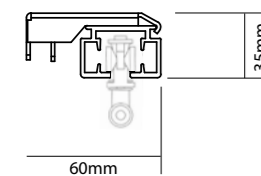

SINGLE FACE FIX

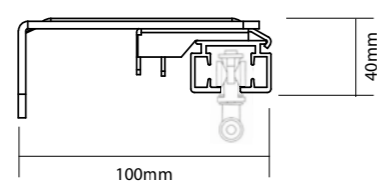

SINGLE TRACK DOUBLE BRACKET

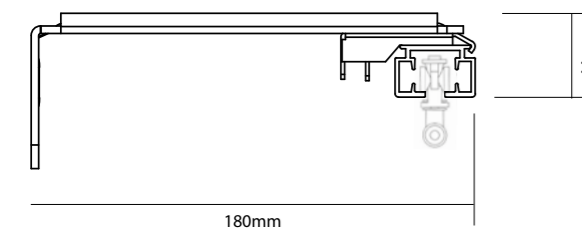

WHEELED RUNNER



Available in: -
80% Fullness = 60mm Spacing
100% Fullness = 54mm Spacing
120% Fullness = 48mm Spacing

TAPE

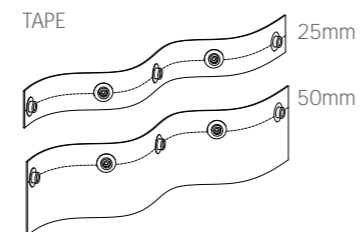

108mm Spacing Between Studs
Available in: -
BLACK / WHITE / TRANSPARENT

• Allowances Shown are from the top of the bracket to the top of the Tape.

Installation & Technical Specifications

S-TRACK PROFILE

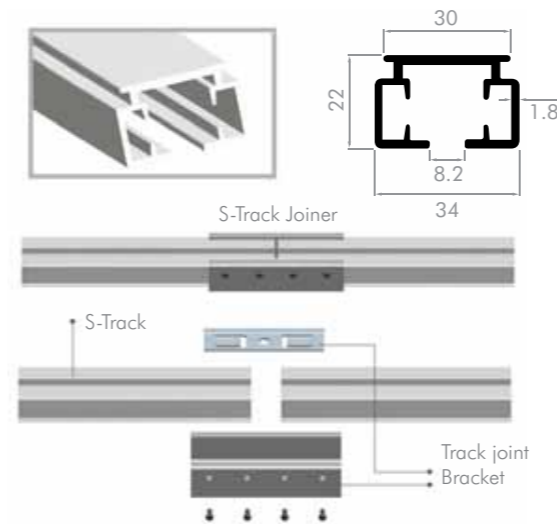

CURTAIN MOTOR DIMENSIONS

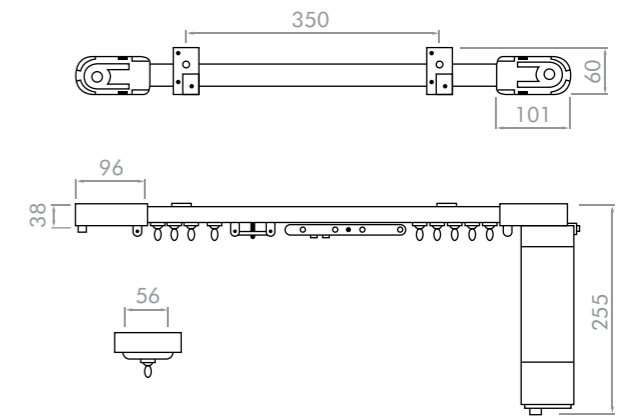

CURTAIN MOTOR CONNECTION



TRACK INSTALLATION DIMENSIONS

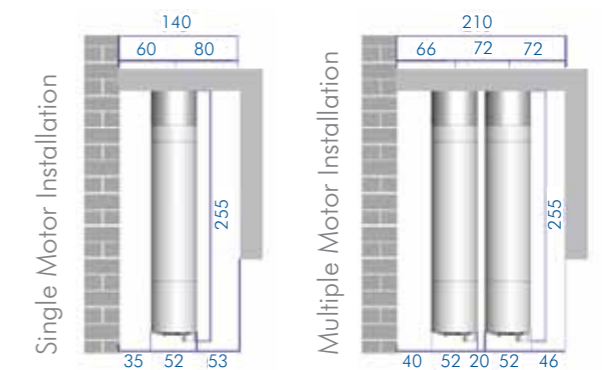

CENTRE OPEN TRACK ASSEMBLY

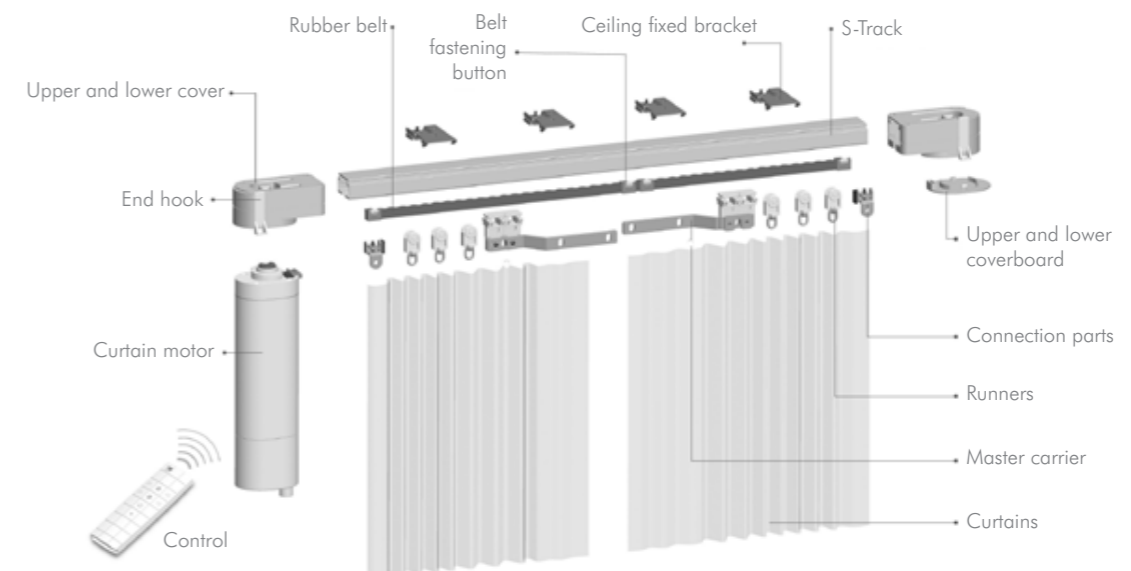



TBS (Aust) Pty. Ltd.

1/16 Metrolink Circuit, Campbellfield,

Melbourne, Australia 3061

Tel: +61 3 8339 2660

Fax: +61 3 8339 2663

Email: sales@tbsaust.net.au

CONTACT YOUR AUTHORISED STOCKIST

